

Keep this
manual onboard!



User Manual

Including Installation Guide for S-Link Display Interface, SDI-1



SLEIPNER GROUP

P.O. Box 519

N-1612 Fredrikstad

Norway

www.sleipnergroupp.com

DOCUMENT ID: 723I

REVISION: 4

DATE: 2024

LANGUAGE: EN



To download your language go to www.sleipnergroupp.com

Contents

Warnings and Safety	2
User Manual	
Responsibility of the Operator	3
Product Description	3
Layout & Functions	3
SDI-1 Technical Specifications	3
SDI-1 Sleipner App	4
SDI-1 Thruster Dashboard	4
SDI-1 Stabilizer Dashboard	5
SDI-1 Alarm Indication.....	6
SDI-1 Setting Menu	7
SDI-1 Firmware Upgrade.....	7
S-Link Fault Codes	8
PDC-301 Fault Codes	8
AMS Fault Codes	8
TP-35 Fault Codes	8
PHC-3 Fault Codes.....	9
eVision and EHP Fault Codes	12
SRC-3 Fault Codes	13
TMU-1 Fault Codes	13
VDRI-1 Fault Codes	13
PPC Fault Codes.....	14
150000 Fault Codes	14
Installation Manual	
Responsibility of the Installer	15
SDI-1 Dimensions.....	16
SDI-1 Installation	17
S-Link System Description	18
Service and Support	19
Product Spare Parts and Additional Resources	19
Warranty Statement	19
Patents	19
CE Declaration of Conformity	20
UK Declaration of Conformity	21

Warnings and Safety

MC_0800

It is essential to follow all information within this document to avoid potential personal injury, death, or damage to existing products, the vessel, and the new product during installation or operation. Failure to follow information within this document will render all warranties given by Sleipner Motor as VOID.

Warnings and situations where extra caution is required are outlined. Take extra consideration when warnings are outlined within the documentation.



WARNING

Indicate a potentially hazardous situation that, if not avoided, could result in death or severe injury.



CAUTION

Indicates a potentially hazardous situation that could result in minor or moderate injury or critical damage to vessel integrity if not avoided.



Sleipner Motor AS
P.O. Box 519, Arne Svendsensgt. 6-8
N-1612 Fredrikstad, Norway

MC_0451

General:

- The operator must read this document to ensure necessary familiarity with the product before use.
- It is the owner/ captain/ operators full responsibility to assess the risk of any unexpected incidents or situation on the vessel or at sea. Familiarise yourself with your vessels safety operation in conjunction with Sleipner products.
- DO NOT allow children to operate Sleipner products.

WARNING
Sleipner Motor AS is not responsible for damage or injury caused by the misuse of our products.

Product Description

S-Link Display Interface (SDI-1) can be used to display status and operational information from Sleipner products on Multi-Function Displays (MFD). All Sleipner S-Link compliant thrusters and stabilizer systems are supported by SDI-1, except PHC-024.

Compatibility

SDI-1 supports MFDs from the following manufacturers:

- Garmin
- Raymarine
- Navico/Simrad

Contact MFD manufacturer for list of compatible models.

Layout & Functions

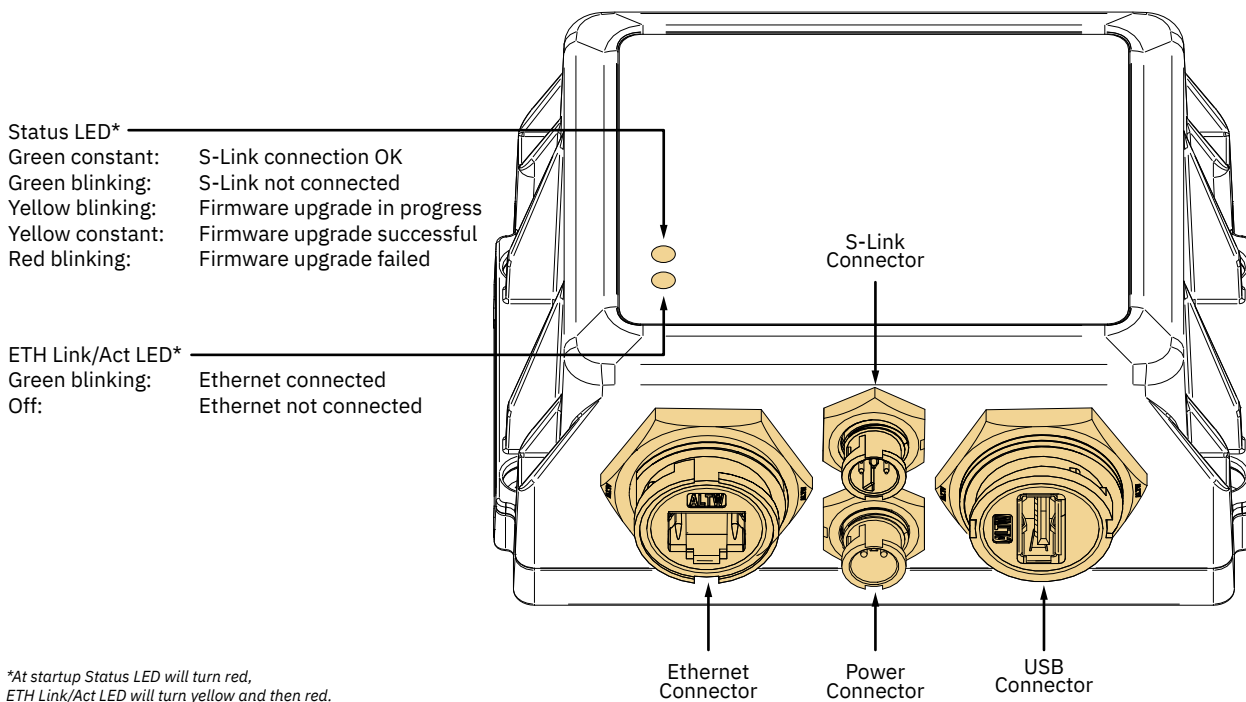

**At startup Status LED will turn red, ETH Link/Act LED will turn yellow and then red.*

SDI-1 Technical Specification

Parameter	Specification		
Supply Voltage	Min 9VDC	Typical 12V/24V	Max 31VDC
Rated max input power:			
Power connector	6.5W		
S-Link connector	1.5W		
Ambient operating temperature	-20°C to +70°C		
IP rating	IP68		
Weight	290g		
Size	84x118x54mm (WxLxH)		

After correct installation and powering up SDI-1 the Sleipner app will appear on MFDs compatible with SDI-1. See MFD user manual for information on how to start third party apps and configuring screen layout.

The Sleipner app offers two dashboards, displaying either thruster or stabilizer information.

SDI-1 Thruster Dashboard

The thruster dashboard view shows thruster type, applied thrust, direction of thrust and status information from up to four thrusters. The status information is oriented on the dashboard according to the physical location of the thrusters.

For installations with two bow thruster, one joystick is used to operate both bow thrusters. The same amount of thrust is therefore applied to both thrusters and there is one common indicator for the amount and direction of thrust of both bow thrusters on the dashboard view. The same applies for vessels with two stern thrusters.

Switching between Thruster and Stabilizer dashboard can be done by clicking on the buttons on the bottom of the touch screen.

Thruster Dashboard Detailed Information

Below is an example of an installation with both bow and stern AC thrusters.

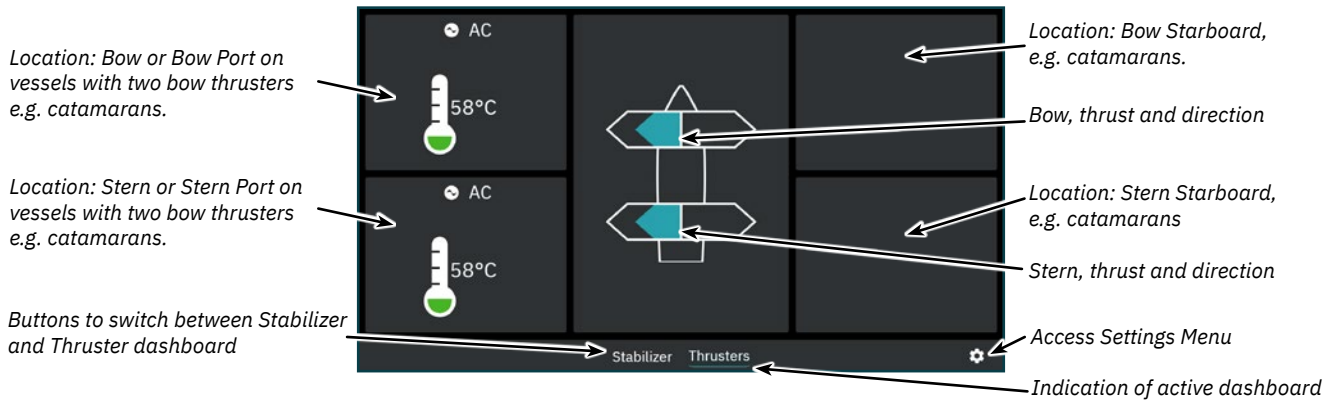

Below figure describes dashboard status information for different thruster types.

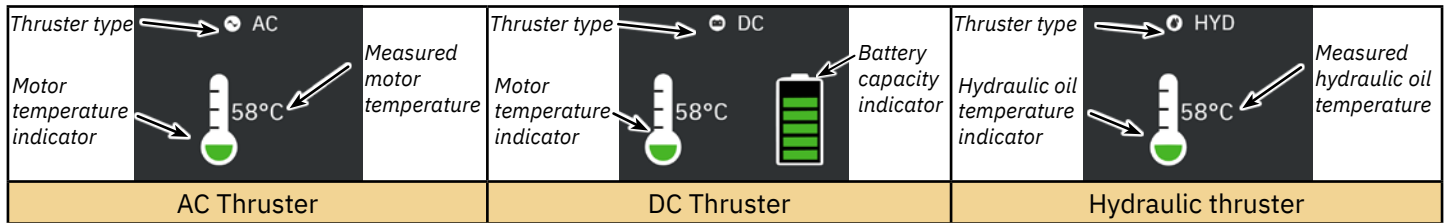

For hydraulic thrusters, the PHC-3 hydraulic controller can be used to control up to two hydraulic thrusters. Thus the dashboard view shows only one hydraulic oil temperature symbol for installations where one PHC-3 hydraulic controller is used to control two thrusters.

The temperature icon has five levels.

Green signifies normal temperature - Yellow signifies high temperature - Red signifies alarm stated due to too high temperature.



The battery status icon for DC thrusters has six levels.

The shaded area in the battery symbol indicates the remaining battery capacity.



Retractable Thruster

Deployment and retracting of retractable thrusters is controlled by turning a control panel ON or OFF. When the control panel is turned ON, retractable thrusters are deployed. The *Deploy* symbol is displayed in the dashboard view until the thruster is fully deployed. Turning OFF the panel will fully retract the thruster and the *Retract* symbol is displayed in the dashboard view until the thruster is fully retracted.

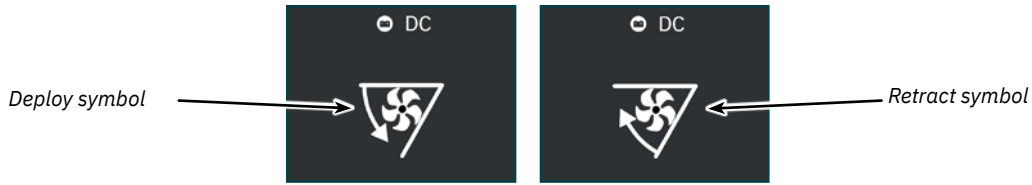

AC Thruster Power Management Status

Some vessels might not have AC power capabilities to run all consumers simultaneously. Such vessels typically use a power management system to control at which time different consumers can be operated. Due to other consumers having higher priority, power to the AC thrusters might not always be available. The following is only applicable for AC thrusters.

When a control panel is turned ON, a request is sent to the Variable Frequency Drive (VFD) to check if power is available. While the control panel waits for power available confirmation from the VFD, operation of the AC thruster is not permitted. The *Waiting for VFD Power Available* symbol is displayed in the dashboard view while the control panel waits for confirmation that power is available for the AC thruster. An alarm is triggered if confirmation is not received within 60 seconds after turning the control panel ON.

See user manual of AC thruster for detailed information on power management operation.

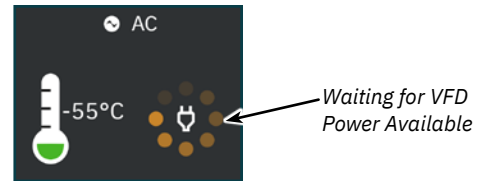

Operation with more than one Control Panel

Several control panels can be connected to the same S-Link bus and configured to control the same thruster. One example could be bridge and deck installation on the same vessel.

If two joysticks controlling the same thruster are moved in the same direction, but with different thrusts, the dashboard view will only indicate the thrust from the joystick with the highest level. Since this is the level of thrust the thruster will operate at.

If two joysticks controlling the same thruster are moved in the opposing direction, the thruster will not respond. In such situations the dashboard view will indicate no thrust. In such situations the thruster will not apply any thrust until one of the joysticks has returned to zero position.

SDI-1 Stabilizer Dashboard

The stabilizer dashboard allows the user to turn the stabilizer system ON and OFF, and switch between At Anchor or Cruising. The roll and speed of the vessel is displayed in the top part of the stabilizer dashboard. Each installed fin is represented by a fin icon on the dashboard. The fin icon displays the actual movement of the fins. A lock icon is used to indicate if the fins are locked in a fixed position.

Switching between Thruster and Stabilizer dashboard can be done by clicking on the buttons on the bottom of the touch screen.

Stabilizer Dashboard Detailed Information

Below is an example of an installation with four stabilizer fins.

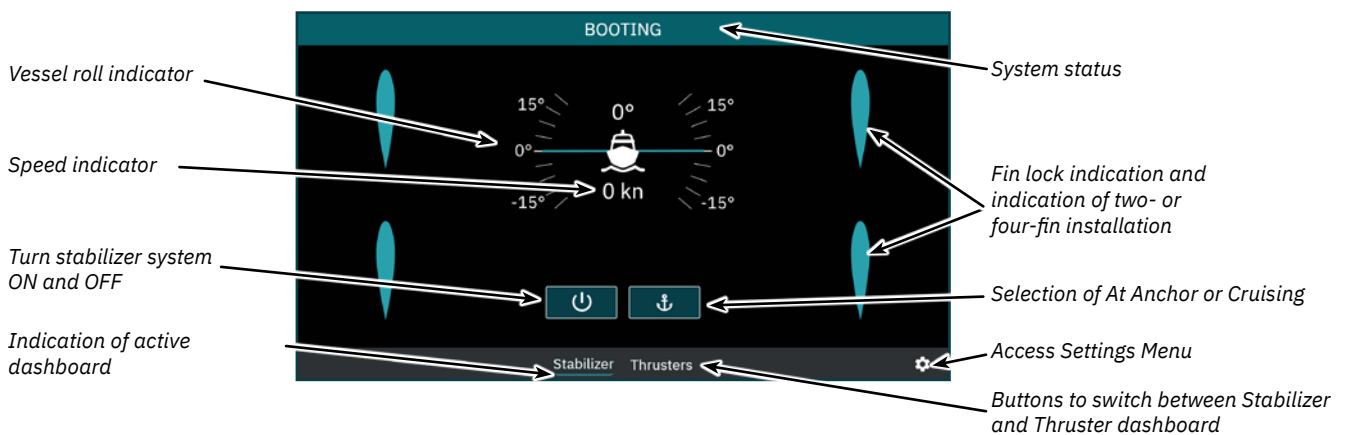

SDI-1 Alarm Indication

If a device connected to the S-Link bus enters an alarm state, an alarm message is broadcasted on the S-Link bus. If an alarm message is detected by SDI-1 a notification will appear on the MFD and additional alarm information will be available. The Sleipner app must be running on the MFD to enable alarm notifications.

Alarm indication thruster dashboard

In the thruster dashboard alarm state is indicated by a blinking red background, and the *Access Alarm List* icon will be displayed in the lower-left corner. Press the *Access Alarm List* icon to show a list of active alarms.

It is not possible to operate a thrusters with active alarms. Exceptions are Oil over temperature- and Low oil level alarms generated by PHC3.

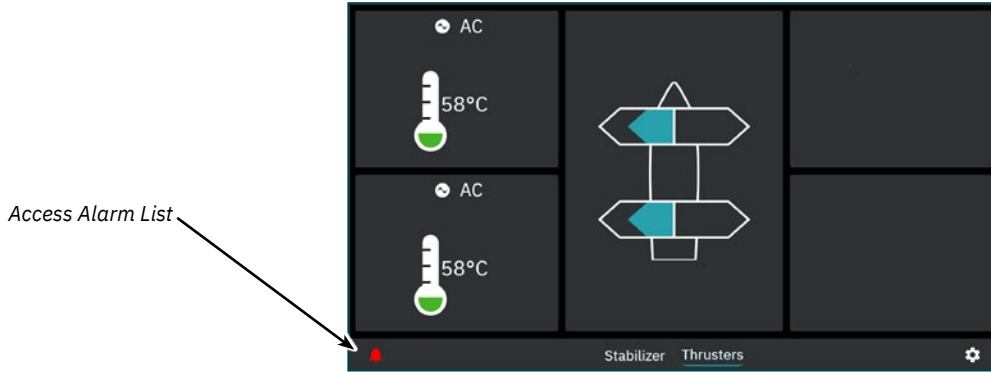

Alarm indication stabilizer dashboard

In the stabilizer dashboard alarm state is indicated by the *Access Alarm List* icon in the lower left corner. Press the *Access Alarm List* icon to show list of active alarms.

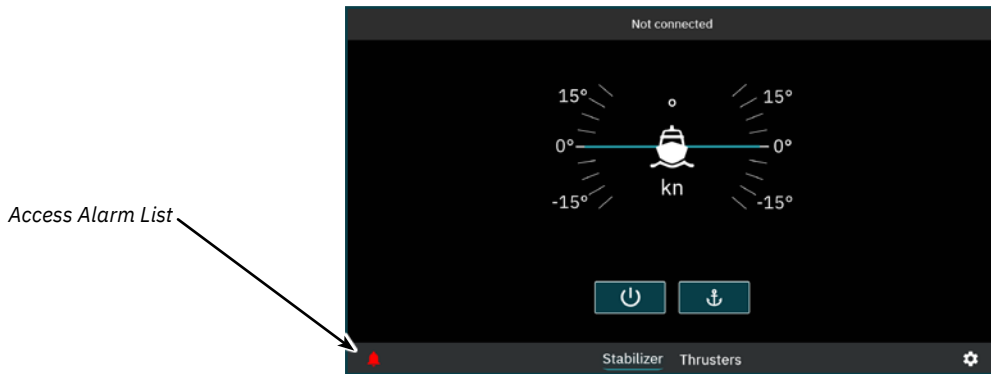

Alarm list

All active thruster and stabilizer alarms are displayed in the alarm list.

DMC_SCU	No instance	45003.100.200
FCU Communication, Fin bow port, Timeout		
DMC_SCU	No instance	45003.101.200
FCU Communication, Fin bow starboard, Timeout		
DMC_SCU	No instance	45003.102.200
FCU Communication, Fin stern port, Timeout		
DMC_SCU	No instance	40004.0.100
PHC-3, -, No Communication		
DMC_SCU	No instance	45003.103.200
FCU Communication, Fin stern starboard, Timeout		

SDI-1 Settings Menu

Configuration settings for stabilizer are available from the *Settings Menu*. In addition SDI-1 FW version, HW version and serial number can be found in the *About* section of the *Setting Menu*.

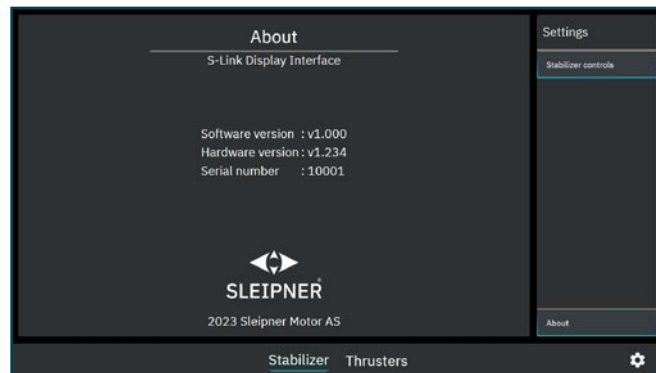

SDI-1 Firmware Upgrade

MC_0547

The USB port on SDI-1 can be used for firmware upgrade by following the steps below:

1. Download the latest firmware to a USB flash drive. The latest firmware can be downloaded from S-Link Programmer, see www.sleipnergroup.com for more information and download of S-Link Programmer.
2. Power up SDI-1 and wait for Status LED to turn green or green blinking.
3. Install the flash drive in the USB port of SDI-1.
4. The Status LED will start blinking yellow when the firmware upload process is started. SDI-1 will function as normal during the firmware upgrade process. If the upgrade fails, the Status LED will turn red. Removing the flash drive after failed upgrade will change the Status LED to green or green blinking.
5. After a successful upgrade the Status LED will stop blinking and turn yellow. SDI-1 must be restarted to start using the new firmware. Removing the flash drive will reboot SDI-1.

S-Link Fault Codes

MC_0472

Fault situations in S-Link compliant products generates Fault Codes which are broadcasted on the S-Link bus. If a control panel receives a Fault Code, it will trigger an alarm in the control panel and the user will be able to get information about which product that reports the fault and the reason for the fault. Please see the user manual of your S-Link compliant control panel for more information on how to access Fault Code information in case of an alarm situation.

All Sleipner S-Link compliant products have product specific Fault Codes. For legacy reasons some control panels display Generic Fault Codes for certain products.

PDC-301 Fault Codes

MC_0119

Fault Code	Description	Cause	Action
106.1.0	Emergency Stop Instance 1 -	Drive in Emergency STOP. Safety circuit signal(s) connected to connector STO or Emergency stop digital input is open.	-Check Emergency stop button. -Check safety circuit connections to STO connector on the drive. -Check Emergency stop digital input connection on the drive.
10600.0.208	Retract Controller - INTERLOCK	Retract Interlock	-Check if retract is deployed. -No communication with Retract Controller, check if Retract Controller has power. -Check PDC-301 and Retract Controller setup.
36100.1.24	VFD Instance 1 Fault	VFD faulted	-See VFD for more information
36100.1.100	VFD Instance 1 No Communication	PDC-301 has no MODBUS communication with VFD.	-Check communication cable with VFD -Check if VFD has power
36101.1.200	VFD PMS Instance 1 Timeout	VFD is not ready within 60 after power request.	-Check if VFD has power
36101.1.204	VFD PMS Instance 1 SIGNAL LOST	Lost Power Management signal from VFD, VFD not available anymore.	-Check VFD for more information.
36103.1.0	VFD IN LOCAL Instance 1 -	VFD in Local or Hand Mode	-Change mode in VFD panel.

AMS Fault Codes

MC_0537

Fault Code	Description	Cause	Action
153.0.24	Supply Voltage - Fault	Supply Voltage Fault	-Check power connections
22000.0.0	AMS Manual Override - -	Main switch manually overridden	-Pull main switch
22001.0.0	AMS Fuse Blown - -	Fuse blown	-Replace fuse -Check if main cable from battery and main cable to thruster has been switched
22002.0.51	Coil - Current High	Contractor coil over current or short circuit	Cycle power to unit and retry, if persistent, contact service

TP-35 Fault Codes

MC_0665

Fault Code	Fault Name	Fault Description	Action
151.0.54	S-Link Power - Undervoltage	S-Link supply voltage below 9.0V or missing	Check S-Link power
152.0.54	AUX Power - Undervoltage	AUX supply voltage below 9.0V or missing	Check AUX power

PHC-3 Fault Codes

MC_0117

Fault Code	Fault Name	Fault Description	Action
106.202.0	Emergency Stop Bow -	Bow emergency stop is button activated	-Release bow emergency stop
106.203.0	Emergency Stop Bow Starboard -	Bow Starboard emergency stop is button activated	-Release bow starboard emergency stop
106.204.0	Emergency Stop Bow Port -	Bow Port emergency stop is button activated	-Release bow port emergency stop
106.205.0	Emergency Stop Stern -	Stern emergency stop is button activated	-Release stern emergency stop
106.206.0	Emergency Stop Stern Starboard -	Stern Starboard emergency stop is button activated	-Release stern starboard emergency stop
106.207.0	Emergency Stop Stern Port -	Stern Port emergency stop is button activated	-Release stern port emergency stop
10500.0.10	PHC Oil Level - Level Low	Hydraulic oil level is low	"-Limit use of thruster -Inspect hydraulic oil level -Check system for leaks and refill hydraulic oil"
10500.0.13	PHC Oil Level - Open Circuit	Analog oil level sensor open circuit	"-Sensor not connected or wire break. -Verify sensor type in parameter 0201 -Disconnect sensor and measure that sensor resistance value is in range 0-180ohm."
10501.0.11	PHC Oil Temp - Level High	Oil temperature higher than 75°C (167°F)	"-Limit use of thruster to prevent temperature to rise. -Check if cooling pump is running and there is cooling water flow. -Inspect seawater filter -Verify that cooling pump is enabled in parameter 0301"
10501.0.13	PHC Oil Temp - Open Circuit	Analog oil temp sensor open circuit	"-Sensor not connected or wire break. - Disconnect sensor and measure that sensor resistance value is in range 104ohm-147Kohm -Wrong sensor is defined in parameter 0201"
10501.0.16	PHC Oil Temp - Short Circuit	Analog oil temp input short circuit	"-Input shorted to GND, check wiring/sensor -Disconnect sensor and measure that sensor resistance value is in range 104ohm-147Kohm"
10501.0.55	PHC Oil Temp - Overtemp	Hydraulic oil temperature has been higher than 120°C (248°F).	"-Wait for oil temperature to cool down. -Check oil level and refill if level is low. -Check if cooling pump is running. -Check if cooling system gets water"
10502.0.13	PHC Stabilizer Pressure - Open Circuit	Stabilizer pressure sensor open circuit	"-Sensor not connected or wire break. -System incorrectly configured with stabilizer, parameter 1001 -Replace sensor"
10502.0.16	PHC Stabilizer Pressure - Short Circuit	Stabilizer pressure sensor short circuit	"-Wires shorted or sensor defective, check wiring/sensor -Replace sensor"
10502.0.19	PHC Stabilizer Pressure - Under Limit	Stabilizer pressure has dropped below 20bar.	"-Check accumulator charge pressure -Check PTO pressure (if PTO powered) -Check system for oil leaks -Check generator power supply to the VFD (is VFD motor speed maximum when pressure alarming low)"
10502.0.20	PHC Stabilizer Pressure - Over Limit	"Stabilizer pressure is higher than: parameter 1013 PTO OVER-PRESSURE FAULT LEVEL running from PTO (FW V1.029 an older, set point + 30bar running from PTO) or set point + 15bar running from AC motor"	"-Check Parameter 1013 PTO OVER-PRESSURE FAULT LEVEL -Check PTO pressure setting -Check accumulator charge pressure -Check unload valve operation"
10502.0.26	PHC Stabilizer Pressure - VALUE MAX	Stabilizer pressure reached sensor max value.	"-Check that correct sensor is fitted -Check that sensor range parameter 1010 match the sensor -Check PTO pressure setting"
10502.0.200	PHC Stabilizer Pressure - Timeout	Stabilizer pressure has not reached 60% of set point parameter 1003 after 30sec.	"-Check pump feed shutoff valve. -Check PTO pressure (if PTO powered) -Check system for oil leaks"
10503.0.13	PHC System Pressure - Open Circuit	System pressure sensor open circuit	"-Sensor not connected or wire break. -Verify system pressure, parameter 0104"
10503.0.16	PHC System Pressure - Short Circuit	System pressure sensor short circuit	"-Wires shorted or sensor defective, check wiring/sensor -Replace sensor"
10504.0.13	PHC AI 1 - Open Circuit	Analog Input 1 (4-20mA) sensor open circuit	-Sensor not connected or wire break.
10504.0.16	PHC AI 1 - Short Circuit	Analog Input 1 (4-20mA) sensor short circuit	"-Wires shorted or sensor defective, check wiring/sensor -Replace sensor"
10505.0.13	PHC AI 2 - Open Circuit	Analog Input 2 (4-20mA) sensor open circuit	-Sensor not connected or wire break.

PHC-3 Fault Codes

MC_0117

Fault Code	Fault Name	Fault Description	Action
10505.0.16	PHC AI 2 - Short Circuit	Analog Input 2 (4-20mA) sensor short circuit	"-Wires shorted or sensor defective, check wiring/sensor -Replace sensor"
10508.0.13	PHC DOUT AC PUMP UNLOAD - Open Circuit	AC Pump Unload valve open circuit	"-Check for open circuit, power consumption < 5.0 Watt -System incorrectly configured with stabilizer, parameter 1001"
10508.0.51	PHC DOUT AC PUMP UNLOAD - Current High	AC Pump Unload valve current higher than 4.0A	-Check wires and connections for short circuit
10509.0.13	PHC DOUT ACCUMULATOR DUMP - Open Circuit	Accumulator Dump valve open circuit	"-Check for open circuit, power < 5.0 Watt -System incorrectly configured with stabilizer, parameter 1001"
10509.0.51	PHC DOUT ACCUMULATOR DUMP - Current High	Accumulator Dump valve current higher than 4.0A	-Check wires and connections for short circuit
10510.0.13	PHC DOUT STABILIZER - Open Circuit	Stabilizer valve open circuit	"-Check for open circuit, power consumption < 5.0 Watt -System incorrectly configured with stabilizer, parameter 1001"
10510.0.51	PHC DOUT STABILIZER - Current High	Stabilizer valve current higher than 4.0A	-Check wires and connections for short circuit
10511.0.13	PHC DOUT COOLING PUMP HYDRAULIC - Open Circuit	Hydraulic Cooling Pump valve open circuit	"-Check for open circuit, power consumption < 5.0 Watt -Wrong cooling pump configured, parameter 0301"
10511.0.51	PHC DOUT COOLING PUMP HYDRAULIC - Current High	Hydraulic Cooling Pump valve current higher than 4.0A	-Check wires and connections for short circuit
10512.0.13	PHC DOUT LS DUMP - Open Circuit	LS-Dump valve open circuit	"-Check for open circuit, power consumption < 5.0 Watt -System wrong configured with thrusters, parameter 2001 or 2101"
10512.0.51	PHC DOUT LS DUMP - Current High	LS-Dump valve current higher than 4.0A	-Check wires and connections for short circuit
10513.0.51	PHC DOUT PUMP #2 - Current High	Pump #2 valve current higher than 4.0A	-Check wires and connections for short circuit
10514.0.13	PHC DOUT 5 - Open Circuit	Digital Output 5 is configured as crossover and output is open circuit	"-Check for open circuit, power consumption < 5.0 Watt -Output configured wrong, parameter 0505"
10514.0.51	PHC DOUT 5 - Current High	Digital Output 5 current higher than 4.0A	-Check wires and connections for short circuit
10515.0.13	PHC DOUT 6 - Open Circuit	Digital Output 6 is configured as crossover and output is open circuit	"-Check for open circuit, power consumption < 5.0 Watt -Output configured wrong, parameter 0506"
10515.0.51	PHC DOUT 6 - Current High	Digital Output 6 current higher than 4.0A	-Check wires and connections for short circuit
10516.0.13	PHC DOUT 3 - Open Circuit	Digital Output 3 is configured as crossover and output is open circuit	"-Check for open circuit, power consumption < 5.0 Watt -Output configured wrong, parameter 0503"
10516.0.51	PHC DOUT 3 - Current High	Digital Output 3 current higher than 4.0A	-Check wires and connections for short circuit
10517.0.13	PHC DOUT 2 - Open Circuit	Digital Output 2 is configured as crossover and output is open circuit	"-Check for open circuit, power consumption < 5.0 Watt -Output configured wrong, parameter 0502"
10517.0.51	PHC DOUT 2 - Current High	Digital Output 2 current higher than 4.0A	-Check wires and connections for short circuit
10518.0.13	PHC DOUT 1 - Open Circuit	Digital Output 1 is configured as crossover and output is open circuit	"-Check for open circuit, power consumption < 5.0 Watt -Output configured wrong, parameter 0501"
10518.0.51	PHC DOUT 1 - Current High	Digital Output 1 current higher than 4.0A	-Check wires and connections for short circuit
10519.0.13	PHC DOUT 4 - Open Circuit	Digital Output 4 is configured as crossover and output is open circuit	"-Check for open circuit, power consumption < 5.0 Watt -Output configured wrong, parameter 0504"
10519.0.51	PHC DOUT 4 - Current High	Digital Output 4 current higher than 4.0A	-Check wires and connections for short circuit
10520.0.51	PHC ECI PUMP POWER FEED - Current High	ECI cooling pump power current higher than 8.0A	"-Check pump cable for damage and short circuits -Make sure the connector on the cooling pump is correct inserted. -Replace cooling pump"
10521.0.51	PHC Bow Thruster Power - Current High	Bow thruster PVG feed current higher than 3.0A	-Check PVG wires and connections for short circuit
10522.0.51	PHC Stern Thruster Power - Current High	Stern thruster PVG feed current higher than 3.0A	-Check PVG wires and connections for short circuit
10523.0.51	PHC Thruster Power - Current High	Bow or Stern PVG feed current higher than 3.3A	Check all bow and stern PVG signal wires for short circuits
10524.0.51	PHC ECI Cooling Pump - Current High	ECI cooling pump current higher than 13.0A	"-Check ECI cooling pump cable for damage and short circuits -Replace ECI cooling pump"
10524.0.53	PHC ECI Cooling Pump - Overvoltage	ECI cooling pump overvoltage, voltage higher than 33.0V	"-Check PHC-3 input voltage is below 33.0V -Replace ECI cooling pump"
10524.0.54	PHC ECI Cooling Pump - Undervoltage	ECI cooling pump under voltage, voltage is lower than 18.0V	"-Check PHC-3 input voltage is higher than 18.0V -Replace ECI cooling pump"
10524.0.55	PHC ECI Cooling Pump - Overtemp	ECI cooling pump temperature higher than 100°C (212°F).	"-Check ECI cooling pump for damages -Replace ECI cooling pump"
10524.0.100	PHC ECI Cooling Pump - No Communication	No communication with ECI cooling pump	"-Check if ECI pump is connected -Check wires to ECI pump for open circuits -Check power supply cooling pump -Wrong cooling pump configured, parameter 0301"
10524.0.205	PHC ECI Cooling Pump - HW FAULT	ECI cooling pump hardware fault	-Replace ECI cooling pump
10526.0.0	PHC ECI Cooling Pump Blocked - -	ECI cooling pump is blocked	"-Reset fault and if fault reappears, cooling pump need service or replacement. -Check pump inlet for obstacles"

PHC-3 Fault Codes

MC_0117

Fault Code	Fault Name	Fault Description	Action
10527.1.0	PHC VFD Not Ready Instance 1 -	VFD not ready	-VFD external run enable/power available signal is lost.
10528.1.10	PHC VFD ABB Parameter Instance 1 Level Low	ABB ACS550 parameter values 2001 or 2002 cannot be a negative value.	-Check ABB ACS550 parameter 2001 and 2002.
10529.0.19	PHC ECI Cooling Pump Speed - Under Limit	ECI pump motor speed under limit. Motor speed is below 100 rpm, or not getting minimum 750 rpm within 3 seconds.	"-Check hose for dirt -Check pump inlet for obstacles"
10530.0.201	PHC PTO ENGINE INSTANCE - INIT FAIL	Parameter 1011-PTO ENGINE INSTANCE is not defined	-Set parameter 1011-PTO ENGINE INSTANCE
10531.0.100	CC MODULE - No Communication	No communication with CC Module	"-Check if CC Module is connected -Check wires to CC Module for open circuits -Check power supply CC Module"
10532.0.24	CC MODULE AC PUMP - Fault	The CC Module AC pump circuit is open and pump is not running	"-Check if AC generator is running -Check if the AC pump contactor is tripped -Check wires to the pump for open circuit"
10533.0.24	CC MODULE DC PUMP - Fault	The CC Module DC pump circuit is open and pump is not running	"-Check if DC pump contactor has 24VDC -Check if the DC pump contactor is tripped -Check wires to the DC pump for open circuit"
10600.202.208	Retract Controller Bow INTERLOCK	Retract Interlock Bow	"-Check if retract is deployed. -No communication with Retract Controller, check if Retract Controller has power and S-link communication. -Check PHC-3 and Retract Controller for correct setup."
10600.203.208	Retract Controller Bow Starboard INTERLOCK	Retract Interlock Bow Starboard	"-Check if retract is deployed. -No communication with Retract Controller, check if Retract Controller has power and S-link communication. -Check PHC-3 and Retract Controller for correct setup."
10600.204.208	Retract Controller Bow Port INTERLOCK	Retract Interlock Bow Port	"-Check if retract is deployed. -No communication with Retract Controller, check if Retract Controller has power and S-link communication. -Check PHC-3 and Retract Controller for correct setup."
10600.205.208	Retract Controller Stern INTERLOCK	Retract Interlock Stern	"-Check if retract is deployed. -No communication with Retract Controller, check if Retract Controller has power and S-link communication. -Check PHC-3 and Retract Controller for correct setup."
10600.206.208	Retract Controller Stern Starboard INTERLOCK	Retract Interlock Stern Starboard	"-Check if retract is deployed. -No communication with Retract Controller, check if Retract Controller has power and S-link communication. -Check PHC-3 and Retract Controller for correct setup."
10600.207.208	Retract Controller Stern Port INTERLOCK	Retract Interlock Stern Port	"-Check if retract is deployed. -No communication with Retract Controller, check if Retract Controller has power and S-link communication. -Check PHC-3 and Retract Controller for correct setup."
36000.1.24	ABB ACS550 Instance 1 Fault	ABB ACS550 fault	Se ABB ACS550 drive for more details
36002.1.24	VACON Instance 1 Fault	VACON VFD Fault	Se VACON drive for more details
36003.1.24	ABB ACS580 Instance 1 Fault	ABB ACS580 fault	Se ABB ACS580 drive for more details
36004.1.24	EHP Instance 1 Fault	EHP Fault	-See fault from EHP for more details
36100.1.100	VFD Instance 1 No Communication	Lost communication with VFD	"-VFD not powered up -VFD communication cable not connected or incorrectly wired -On the VFD make sure the RS485 BUS TERMINATION is in ON position"
36103.1.0	VFD IN LOCAL Instance 1 -	VFD in local mode	-Switch VFD to remote mode

Fault Code	Description	Cause	Action
100.0.0	System Error - -	Internal error	-Consult Side-Power dealer
107.0.24	Bootloader fault code - Fault	Bootloader failed upgrading.	-Check S-link cables and T-connectors. -If problem persist, consult Sleipner dealer.
155.0.24	Internal Voltage - Fault	Internal error	-If problem persist, consult Sleipner dealer.
10000.106.55	Motor Temp - Overtemp	Stator over temperature	-Wait for motor to cool down
10002.0.13	Stator Temperature - Open Circuit	Stator temperature sensor not connected	-If problem persist, consult Sleipner dealer.
10002.0.16	Stator Temperature - Short Circuit	Stator temperature sensor short circuit	-If problem persist, consult Sleipner dealer.
10003.0.13	Transistor Temperature - Open Circuit	Transistor temperature sensor not connected	-If problem persist, consult Sleipner dealer.
10003.0.16	Transistor Temperature - Short Circuit	Transistor temperature sensor short circuit	-If problem persist, consult Sleipner dealer.
10101.106.55	Device CPU Temp - Overtemp	Main MCU temperature above max limit	-Wait for motor to cool down
10101.107.55	Device CPU Temp - Overtemp	Motor MCU temperature above max limit	-Wait for motor to cool down.
10102.106.55	Device Board Temperature - Overtemp	Transistor over temperature	-Wait for motor to cool down
10104.106.24	Motor Speed - Fault	Motor speed outside valid range.	-Check propeller blades and flexible coupling.
10104.107.212	Motor Speed - Overspeed	Motor speed outside valid range	-Check propeller blades and flexible coupling. -If not resolved consult Sleipner representative.
10200.106.53	System Voltage - Overvoltage	Main MCU temperature above max limit	-Measure voltage at battery terminals and thruster terminals.
10200.106.54	System Voltage - Undervoltage	Motor supply voltage below min limit	-Measure voltage at battery terminals and thruster terminals.
10200.107.53	System Voltage - Overvoltage	Motor supply voltage above max limit	-Measure voltage at battery terminals and thruster terminals.
10200.107.54	System Voltage - Undervoltage	Motor supply voltage below min limit	-Measure voltage at battery terminals and thruster terminals.
10301.0.19	Motor Position - Under Limit	Encoder magnitude under limit	-If problem persist, consult Sleipner dealer.
10301.0.20	Motor Position - Over Limit	Encoder magnitude over limit	-If problem persist, consult Sleipner dealer.
10301.0.100	Motor Position - No Communication	Communication with speed sensor failed	-If problem persist, consult Sleipner dealer.
10301.107.212	Motor Position - Overspeed	Motor fails to stop correctly	-If problem persist, consult Sleipner dealer.
10302.107.24	uC Communication - Fault	Communication between internal MCUs failed	-If problem persist, consult Sleipner dealer.
10302.107.100	uC Communication - No Communication	Communication between internal MCUs timeout	-If problem persist, consult Sleipner dealer.
10303.107.20	Motor Torque - Over Limit	Motor torque above max limit	-Check if propeller is obstructed. -If not resolved consult Sleipner dealer.
10600.0.24	Retract Controller - Fault	Fault detected on retract	-Check retract faults
10600.0.208	Retract Controller - INTERLOCK	Function or Location configuration does not match retract controller configuration	-Check configuration of installed devices.
30100.0.13	Thruster Motor Current - Open Circuit	Motor phase not connected.	-If problem persist, consult Sleipner dealer.
30100.107.57	Thruster Motor Current - Overcurrent	Measured motor phase current above max limit	-Check if propeller is blocked. -If not resolved consult Sleipner dealer.
60000.0.13	Main Fan - Open Circuit	Cooling fan temperature measurement open circuit	-If problem persist, consult Sleipner dealer.
60000.0.16	Main Fan - Short Circuit	Cooling fan temperature measurement short circuit	-If problem persist, consult Sleipner dealer.
60000.0.50	Main Fan - Current Low	Cooling fan current consumption below min limit	-If problem persist, consult Sleipner dealer.
60000.0.51	Main Fan - Current High	Cooling fan current consumption above max limit	-If problem persist, consult Sleipner dealer.
60000.0.53	Main Fan - Overvoltage	Cooling fan supply voltage above max limit	-If problem persist, consult Sleipner dealer.
60000.0.54	Main Fan - Undervoltage	Cooling fan supply voltage below min limit	-If problem persist, consult Sleipner dealer.
60000.0.55	Main Fan - Overtemp	Cooling fan power supply temperature above max limit	-Wait for motor to cool down
60000.0.211	Main Fan - Underspeed	Cooling fan speed below limit	-If problem persist, consult Sleipner dealer.
60000.0.212	Main Fan - Overspeed	Cooling fan speed above limit	-If problem persist, consult Sleipner dealer.

SRC-3 Fault Codes

MC_0636

Fault Code	Fault Name	Fault Description	Action
100.0.0	System Error - -	System Error	Contact Sleipner Dealer
153.0.151	Supply Voltage - Self-Test Fault	Failed to determine voltage level of the system / Out of range.	Verify that the correct battery was chosen for this system and that it is properly charged.
10600.0.101	Retract Controller - Bus Off	Actuator CAN experienced Bus Off/Bus error.	Verify CAN cables to the actuators are correctly connected.
10600.0.210	Retract Controller - Service Mode	In Service Mode.	Exit service mode by using button controls.
10602.0.22	Retract Motion OUT Fault - Out of position	Lift or Lock Actuators went past their expected end-position when hatch deploying.	Inspect actuators and lifting arms for visual damage. Check fault specific data for more info. Contact Sleipner Dealer if problem is not resolved.
10602.0.51	Retract Motion OUT Fault - Current High	Blocked while deploying hatch.	Find and remove cause of mechanical blockage.
10603.0.22	Retract Motion IN Fault - Out of position	Lift or Lock Actuators went past their expected end-position when hatch retracting.	Inspect actuators and lifting arms for visual damage. Verify that the hatch fits the hull according to specification. Check fault specific data for more info. Contact Sleipner Dealer if problem is not resolved.
10603.0.51	Retract Motion IN Fault - Current High	Blocked while retracting hatch.	Find and remove cause of mechanical blockage.
10605.1.24	Lift Actuator Instance 1 Fault	Lift Actuator 1 Reported a Fatal Error	Contact Sleipner Dealer.
10605.1.53	Lift Actuator Instance 1 Overvoltage	Lift Actuator 1 Measured Overvoltage	Verify that the correct battery was chosen for this system.
10605.1.54	Lift Actuator Instance 1 Undervoltage	Lift Actuator 1 Measured Undervoltage	Verify that battery is charged.
10605.1.55	Lift Actuator Instance 1 Overtemp	Lift Actuator 1 Temperature Exceeding >85C	Find and eliminate cause of high temperature.
10605.1.100	Lift Actuator Instance 1 No Communication	Lift Actuator 1 Not Communicating	Verify that CAN and supply cables are correctly connected, and that no fuses have gone out.
10605.1.209	Lift Actuator Instance 1 MOTION FAULT	Lift Actuator 1 experienced linear motion while it was supposed to be in a fixed position. Load might have caused backdrive.	Look for mechanical obstruction/causes for the backdrive and remove them.
10605.2.24	Lift Actuator Instance 2 Fault	Lift Actuator 2 Reported a Fatal Error	Contact Sleipner Dealer.
10605.2.53	Lift Actuator Instance 2 Overvoltage	Lift Actuator 2 Measured Overvoltage	Verify that the correct battery was chosen for this system.
10605.2.54	Lift Actuator Instance 2 Undervoltage	Lift Actuator 2 Measured Undervoltage	Verify that battery is charged.
10605.2.55	Lift Actuator Instance 2 Overtemp	Lift Actuator 2 Temperature Exceeding >85C	Find and eliminate cause of high temperature.
10605.2.100	Lift Actuator Instance 2 No Communication	Lift Actuator 2 Not Communicating	Verify that CAN and supply cables are correctly connected, and that no fuses have gone out.
10605.2.209	Lift Actuator Instance 2 MOTION FAULT	Lift Actuator 2 experienced linear motion while it was supposed to be in a fixed position. Load might have caused backdrive.	Look for mechanical obstruction/causes for the backdrive and remove them.
10606.1.24	Lock Actuator Instance 1 Fault	Lock Actuator 1 Reported a Fatal Error, could be broken.	Contact Sleipner Dealer.
10606.1.53	Lock Actuator Instance 1 Overvoltage	Lock Actuator 1 Measured Overvoltage	Verify that the correct battery was chosen for this system.
10606.1.54	Lock Actuator Instance 1 Undervoltage	Lock Actuator 1 Measured Undervoltage	Verify that battery is charged.
10606.1.55	Lock Actuator Instance 1 Overtemp	Lock Actuator 1 Temperature Exceeding >85C	Find and eliminate cause of high temperature.
10606.1.100	Lock Actuator Instance 1 No Communication	Lock Actuator 1 Not Communicating	Verify that CAN and supply cables are correctly connected, and that no fuses have gone out.
10606.1.209	Lock Actuator Instance 1 MOTION FAULT	Lock Actuator 1 experienced linear motion while it was supposed to be in a fixed position. Load might have caused backdrive.	Look for mechanical obstruction/causes for the backdrive and remove them.
10607.0.209	Actuator Alignment Fault - MOTION FAULT	There was a position discrepancy between the lift actuators, but alignment failed.	Look for mechanical obstruction/causes for alignment failure.

TMU-1 Fault Codes

MC_0470

Fault Code	Fault Name	Fault Description	Action
10103.0.10	Gearleg Oil - Level Low	Gearleg oil level is low	-Check level indicator on the external oil tank. If low oil level in tank, refill oil and check gearleg for leakage. -If oil level is ok, check that cable between TMU-1 and oil tank sensor is connected and not damaged.
10104.0.212	Motor Speed - Overspeed	Motor speed higher than 5.000 RPM	-Verify that Pulse Per Revolution configuration on TMU-1 matches RPM sensor specification. -Check that cable between TMU-1 and RPM sensor is connected and not damaged.

VDRI-1 Fault Codes

MC_0449

Fault Code	Fault Name	Fault Description	Action
109.0.0	Configuration Error - -	-No Speed Source configured. At least one instance must be configured for VDRI to log data. -Instance configured to receive data from PDC-301, but receive data from TMU-1 or vice versa. -An instance receives data when no Speed Source is configured, or vice versa.	Check configuration and installed devices on S-Link bus.

PPC Fault Codes

MC_0538

Fault Code	Description	Cause	Action
10000.0.11	Motor Temp - Level High	Motor temperature is higher than 120C/248F	- Motor must cool down to below 110C/230F
10000.0.13	Motor Temp - Open Circuit	Motor temperature sensor open circuit	-Check for open circuit on the temperature sensor on the motor
10000.0.16	Motor Temp - Short Circuit	Motor temperature sensor short circuit	-Check for short circuit on the temperature sensor on the motor
10001.0.13	Motor Thermo Switch - Open Circuit	Thermoswitch input is activated	-Motor needs to cool down before operated again -If motor is not warm then check for thermoswitch open circuit or wrong setup
10100.0.11	Device Cooling Fin Temp - Level High	PPC controller temperature is higher than 80C/176F	-PPC must cool down to below 45C/113F
10200.0.10	System Voltage - Level Low	Low motor voltage when motor is running. 12V thruster below 8.0V 24V thruster below 12.0V	-Reset or power OFF, wait 30sec and power ON the PPC -Recharge thruster battery
20000.0.73	IPC - Contact Before Energized	IPC error, motor relay fault before energized	-Turn off thruster battery main switch. -Thruster must be serviced by authorized personnel
20000.200.70	IPC Starboard No Contact Energized	IPC error, motor relay no contact when energized to starboard side	-Turn off thruster battery main switch. -Thruster must be serviced by authorized personnel -If motor running up to 60% then check if A2 white wire is connected
20000.201.70	IPC Port No Contact Energized	IPC error, motor relay no contact when energized to port side	-Turn off thruster battery main switch. -Thruster must be serviced by authorized personnel -If motor running up to 60% then check if A2 white wire is connected
30000.200.51	Thruster Solenoid Starboard Current High	Motor starboard contactor fault	-Check motor contactor connections -Check for short circuit -Check for dead relay
30000.201.51	Thruster Solenoid Port Current High	Motor port contactor fault	-Check motor contactor connections -Check for short circuit -Check for dead relay
30100.0.51	Thruster Motor Current - Current High	Motor current too high	-Reset or power OFF, wait 30sec and power ON the PPC -Check for marine growth on propeller and tunnel -Check obstacles in the thruster tunnel -If not resolved, thruster must be serviced by authorized personnel
30100.0.52	Thruster Motor Current - Current Critical	Motor current critical high	-Reset or power OFF, wait 30sec and power ON the PPC -If not resolved, thruster must be serviced by authorized personnel
30300.0.19	Cooling Fan Speed - Under Limit	Cooling fan stopped or running too slow	PPC must be serviced by authorized personnel

150000 Fault Codes

MC_0671

Fault Code	Description	Cause	Action
10000.0.11	Motor Temp - Level High	Motor temp has been over 120C (248F)	Motor cool down below 110C (230F)
10000.0.13	Motor Temp - Open Circuit	Motor temperature sensor open circuit	-Check motor temperature sensor wires for open circuit.
10000.0.16	Motor Temp - Short Circuit	Motor temperature sensor short circuit	-Check motor temperature sensor wires for short circuit.
10003.0.11	Transistor Temperature - Level High	Actuator transistor temperature is high	-Control box needs to cool down
10200.0.54	System Voltage - Undervoltage	"Low motor voltage alarm when motor is running. 12V thruster below 8.00V 24V thruster below 12.00V"	-Recharge battery, reset or power OFF/ON device.
10600.0.210	Retract Controller - Service Mode	Retract controller in service mode. Switch no. 4 is ON.	-Check dip switch setting on retract control box.
10601.0.24	Retract Position Sensor - Fault	Position sensor fault	-Check position sensor cables and sensor for damage
10602.0.50	Retract Motion OUT Fault - Current Low	Actuator current is below 0.5A when deploying	"-Check actuator connection or power to actuator. -If actuator is warm, try again when actuator has cooled down."
10602.0.51	Retract Motion OUT Fault - Current High	Retract obstructed while deploying	-Turn off all panels. Go for lower speed/deeper water and retry
10603.0.50	Retract Motion IN Fault - Current Low	Actuator current is below 0.5A when retracting	"-Check actuator connection or power to actuator. -If actuator is warm, try again when actuator has cooled down."
10603.0.51	Retract Motion IN Fault - Current High	Retract obstructed while retracting	-Turn panel on and manually override main switch. Remove obstruction and try again.
10604.0.203	Retract Shaft - Not Calibrated	Shaft Not Calibrated	-See manual for how to calibrate.
20000.0.72	IPC - Contact After Deenergized	Solenoid has contact after de-energized	-Turn off thruster battery main switch. Thruster must be serviced by authorized personnel.
20000.0.73	IPC - Contact Before Energized	Solenoid has contact when not energized	-Turn off thruster battery main switch. Thruster must be serviced by authorized personnel.
20000.200.70	IPC Starboard No Contact Energized	Solenoid has no contact when energized to starboard side	-Turn off thruster battery main switch. Thruster must be serviced by authorized personnel.
20000.201.70	IPC Port No Contact Energized	Solenoid has no contact when energized to port side	-Turn off thruster battery main switch. Thruster must be serviced by authorized personnel.
30000.200.51	Thruster Solenoid Starboard Current High	Motor starboard solenoid high current	-Check starboard solenoid connections for short circuit
30000.201.51	Thruster Solenoid Port Current High	Motor port solenoid high current	-Check port solenoid connections for short circuit

Responsibility of the Installer

MC_0038

General:

- The installer must read this document to ensure necessary familiarity with the product before installation.
- Directions outlined in this document cannot be guaranteed to comply with all international and national regulations, including but not limited to health and safety procedures. It is the installer's responsibility to adhere to all applicable international and national regulations when installing Sleipner products.
- This document contains general installation guidelines intended to support experienced installers. Contact professional installers familiar with the vessel and applicable regulations if assistance is required.
- If local regulation requires any electrical work to be performed by a licensed professional, seek a licensed professional.
- To accommodate for future service and inspection requirements, ensure appropriate access to Sleipner products during the installation planning phase.

For Sleipner S-Link™ systems:

MC_0105

When installing an S-Link™ system, connect ONLY original Sleipner S-Link™ products or other authorized control equipment directly to the S-Link™ bus. When connecting non-authorized third-party equipment, it must always be connected through a Sleipner-supplied interface product.

Any attempt to directly control or connect to the S-Link™ control system without a designated and approved interface from Sleipner will void all warranties and responsibilities of the connected Sleipner products. If you interface the S-Link™ bus by agreement with Sleipner through a designated Sleipner-supplied interface, you are still required to install at least one original Sleipner control panel to enable efficient troubleshooting if necessary.

Dimension code	Dimension description	mm	inch
L	Length	118	2
W	Width	84	4,6
H	Height	54	3,3
(a)	Distance between mounting holes	46	1,8
(b)	Distance between mounting holes	108	4,3

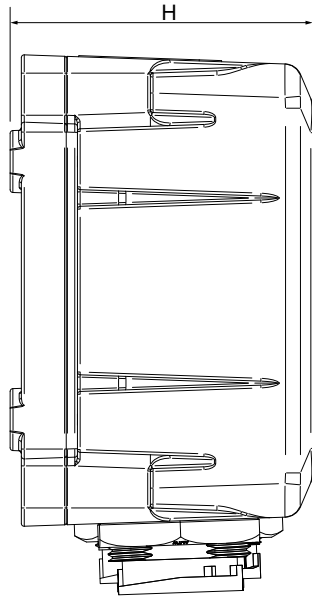
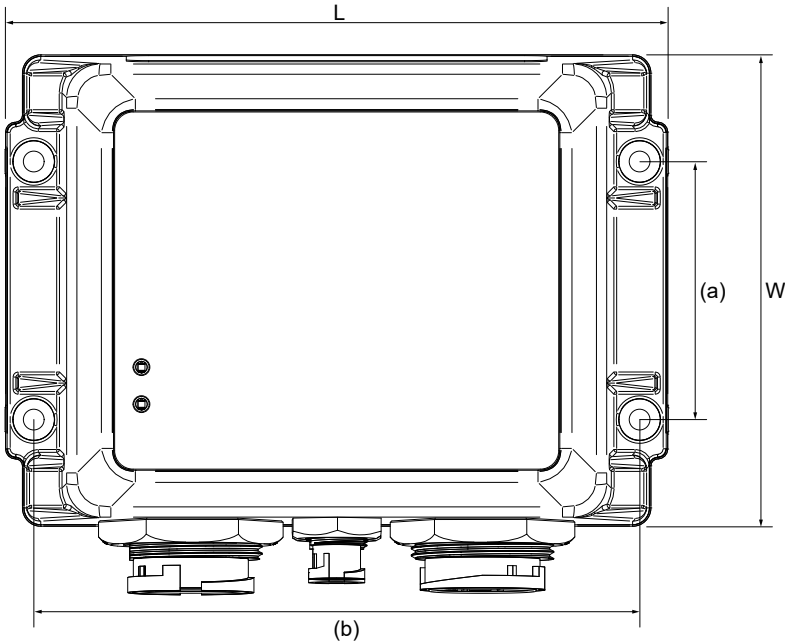

MG_0703

1. Fasten the SDI-1 box to a solid surface using four mounting screws.
2. Connected a S-Link SPUR Cable between SDI-1 and a T-connector on the S-Link BACKBONE Cable. See *S-Link System Description* chapter for detailed information about the S-Link system.
3. Connect an Ethernet cable between SDI-1 and the Multi-Function Display (MFD). For most MFDs the Ethernet cable could be connected to a switch on the same net as the MFD.
4. Connect power cable supplying 12V/24V. The supply should be protected with a 1A/0.5A fuse. To be able to completely turn off SDI-1 a switch could be connected on the supply.

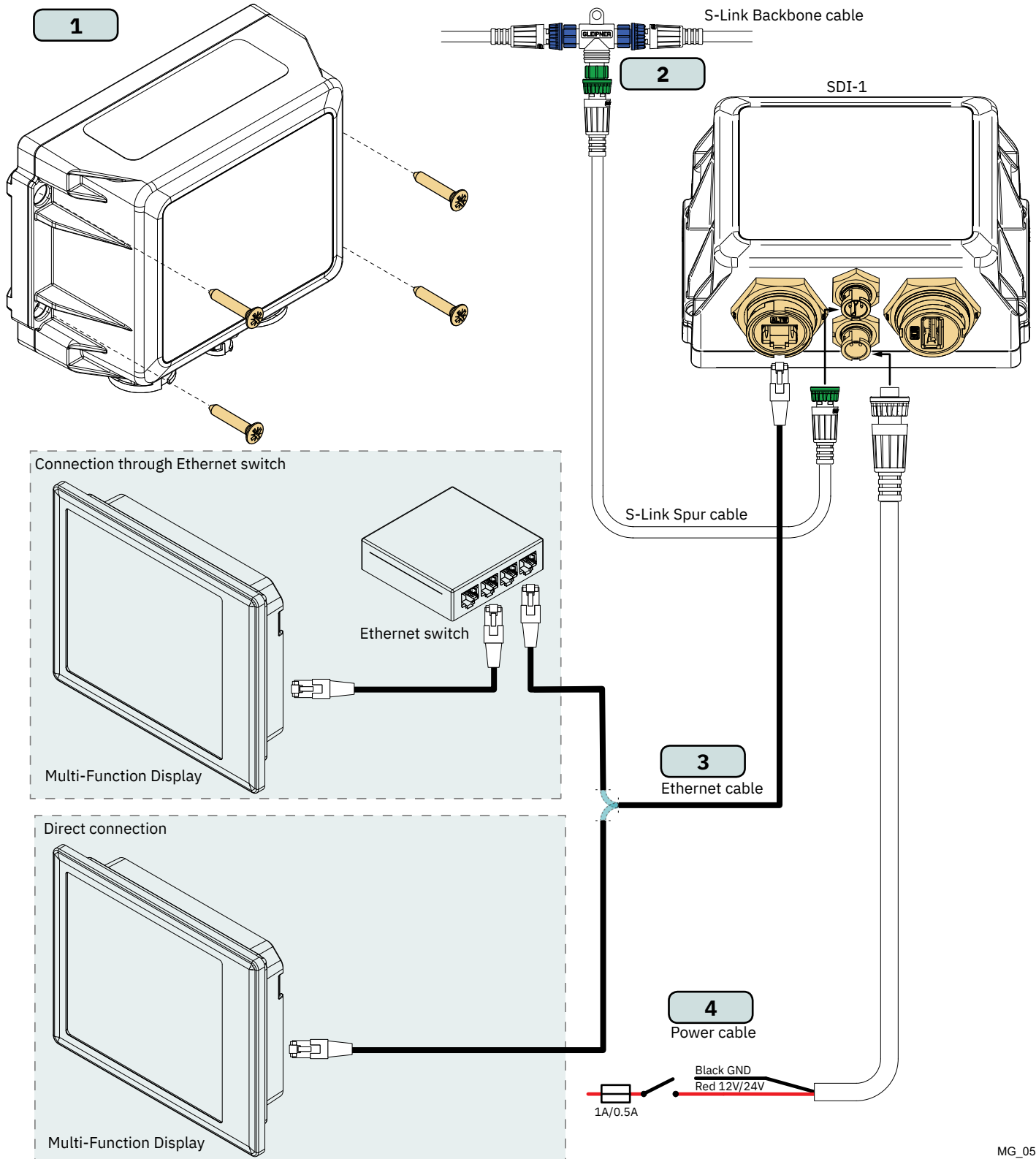

S-Link is a CAN-based control system used for communication between Sleipner products installed on a vessel. The system uses BACKBONE Cables as a common power and communication bus with separate SPUR Cables to each connected unit. Only one S-Link POWER cable shall be connected to the BACKBONE Cable. Units with low power consumption are powered directly from the S-Link bus.

Main advantages of S-Link system:

- Compact and waterproof plugs.
- BACKBONE and SPUR Cables have different colour coding and keying to ensure correct and easy installation. BACKBONE Cables have blue connectors and SPUR Cables have green connectors.
- Different cable lengths and BACKBONE Extenders make the system scalable and flexible to install.

Installation of S-Link cables:

Select appropriate cables to keep the length of BACKBONE- and SPUR Cables to a minimum. In case of planned installation with total BACKBONE Cable length exceeding 100 meters please consult your local distributor. The S-Link cables should be properly fastened when installed to avoid sharp bend radius, cable chafing and undesired strain on connectors. Locking mechanism on connectors must be fully closed. To ensure long lifetime, cables, T-Connectors and Extenders should not be located so that they are permanently immersed in water or other fluids. It is also recommended to install cables such that water and condensation do not run along the cables and into the connectors.

The POWER Cable should ideally be connected around the middle of the BACKBONE bus to ensure an equal voltage drop at each end of the BACKBONE Cable. The yellow and black wire in the POWER Cable shall be connected to GND and the red wire connected to +12VDC or +24VDC.

To reduce the risk of interference, avoid routing the S-Link cables close to equipment such as radio transmitters, antennas or high voltage cables. The backbone must be terminated at each end with the END Terminator.

SPUR cables can be left unterminated to prepare for the installation of future additional equipment. In such cases, ensure to protect open connectors from water and moisture to avoid corrosion in the connectors.

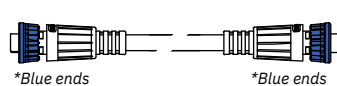

BACKBONE Cable

Forms the communication and power bus throughout a vessel. Available in different standard lengths.

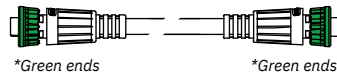

SPUR Cable

Used to connect S-Link compliant products to the backbone cable. One SPUR Cable must be used for each connected component, with no exceptions. Recommended to be as short as practically possible. Available in different standard lengths.



POWER Cable

Required in all installations for connection of BACKBONE Cable to a power supply and should be protected with a 2A fuse.

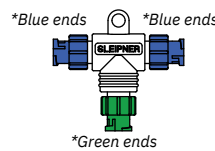

T-Connector

Used for connection of SPUR or POWER Cable to the BACKBONE Cable. One T-Connector for each connected cable.



BACKBONE Extender

Connects two BACKBONE Cables to extend the length.

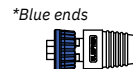

END Terminator

Must be one at each end of the BACKBONE bus.

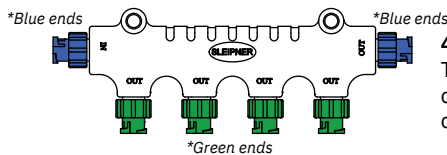

4-Port T-Connector

The 4-PORT T-connector allows multiple SPUR Cables to be connected. The 4-PORT T-connector comes with two sealing caps to protect unused ports.

S-Link installation example

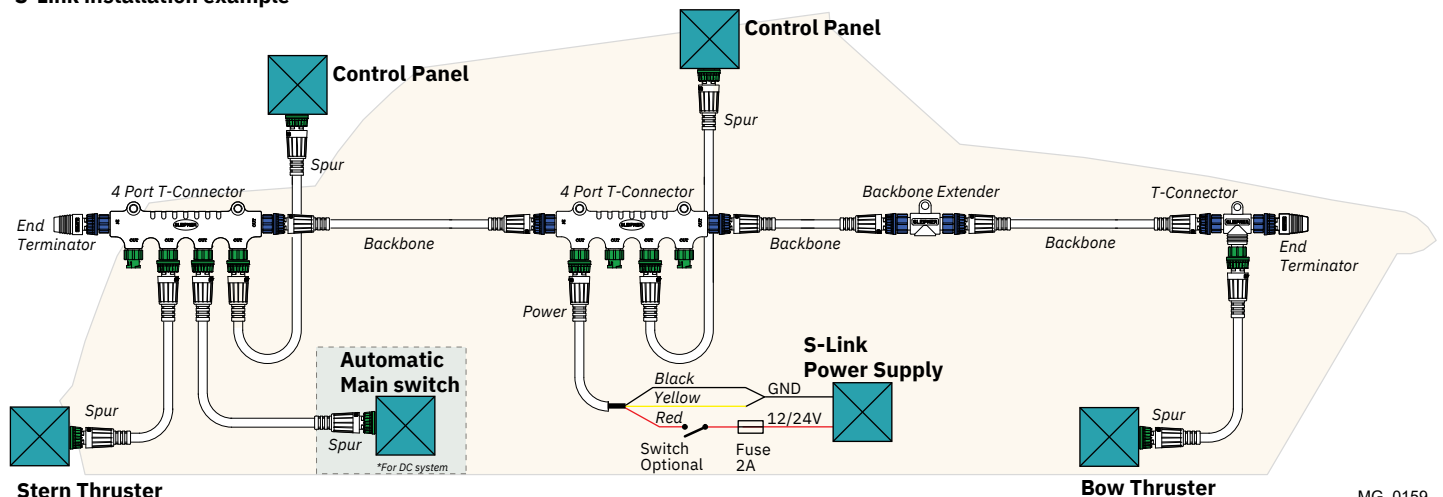

Find your local professional dealer from our certified worldwide network for expert service and support. visit our website www.sleipnergrouper.com/support

Product Spare Parts and Additional Resources

For additional supporting documentation, we advise you to visit our website www.sleipnergrouper.com and find your Sleipner product.

Warranty statement

1. Sleipner Motor AS (The "Warrantor") warrants that the equipment (parts, materials, and embedded software of products) manufactured by the Warrantor is free from defects in workmanship and materials for purpose for which the equipment is intended and under normal use and maintenance service (the "Warranty").
2. This Warranty is in effect for two years (Leisure Use) or one year (Commercial and other Non-leisure Use) from the date of delivery/purchase by the end user, with the following exceptions;
 - (a) For demonstration vessels, or vessels kept on the water, the dealer is considered as the end user from 6 months after their launch of the vessel;
 - (b) The warranty period starts no later than 18 months after the first launch of the vessel.
 Please note that the boat manufacturer and dealer must pay particular attention to correct maintenance and service both by the products manuals as well as general good practice for the location the boat is kept in the period the boat is in their care. In cases where the 6 and 18 months grace periods for boat builders and dealers are passed, it is possible to obtain a full warranty upon inspection and approval of the warrantor or such representative.
3. Certain parts, classified as wearable or service parts, are not covered by the warranty. A failure to follow the required maintenance and service work as described in the product manual render all warranty on parts or components directly or indirectly affected by this void. Please also note that for some parts, time is also a factor separately from actual operational hours.
4. This Warranty is transferable and covers the equipment for the specified warranty period.
5. The warranty does not apply to defects or damages caused by faulty installation or hook-up, abuse or misuse of the equipment including exposure to excessive heat, salt or fresh water spray, or water immersion except for equipment specifically designed as waterproof.
6. In case the equipment seems to be defective, the warranty holder (the "Claimant") must do the following to make a claim:
 - (a) Contact the dealer or service centre where the equipment was purchased and make the claim. Alternatively, the Claimant can make the claim to a dealer or service centre found at www.sleipnergrouper.com. The Claimant must present a detailed written statement of the nature and circumstances of the defect, to the best of the Claimant's knowledge, including product identification and serial nbr., the date and place of purchase and the name and address of the installer. Proof of purchase date should be included with the claim, to verify that the warranty period has not expired;
 - (b) Make the equipment available for troubleshooting and repair, with direct and workable access, including dismantling of furnishings or similar, if any, either at the premises of the Warrantor or an authorised service representative approved by the Warrantor. Equipment can only be returned to the Warrantor or an authorised service representative for repair following a pre-approval by the Warrantor's Help Desk and if so, with the Return Authorisation Number visible postage/shipping prepaid and at the expense of the Claimant.
7. Examination and handling of the warranty claim:
 - (a) If upon the Warrantor's or authorised service Representative's examination, the defect is determined to result from defective material or workmanship in the warranty period, the equipment will be repaired or replaced at the Warrantor's option without charge, and returned to the Purchaser at the Warrantor's expense. If, on the other hand, the claim is determined to result from circumstances such as described in section 4 above or a result of wear and tear exceeding that for which the equipment is intended (e.g. commercial use of equipment intended for leisure use), the costs for the troubleshooting and repair shall be borne by the Claimant;
 - (b) No refund of the purchase price will be granted to the Claimant, unless the Warrantor is unable to remedy the defect after having a reasonable number of opportunities to do so. In the event that attempts to remedy the defect have failed, the Claimant may claim a refund of the purchase price, provided that the Claimant submits a statement in writing from a professional boating equipment supplier that the installation instructions of the Installation and Operation Manual have been complied with and that the defect remains.
8. Warranty service shall be performed only by the Warrantor, or an authorised service representative, and any attempt to remedy the defect by anyone else shall render this warranty void.
9. No other warranty is given beyond those described above, implied or otherwise, including any implied warranty of merchantability, fitness for a particular purpose other than the purpose for which the equipment is intended, and any other obligations on the part of the Warrantor or its employees and representatives.
10. There shall be no responsibility or liability whatsoever on the part of the Warrantor or its employees and representatives based on this Warranty for injury to any person or persons, or damage to property, loss of income or profit, or any other incidental, consequential or resulting damage or cost claimed to have been incurred through the use or sale of the equipment, including any possible failure or malfunction of the equipment or damages arising from collision with other vessels or objects.
11. This warranty gives you specific legal rights, and you may also have other rights which vary from country to country.

Patents

At Sleipner we continually reinvest to develop and offer the latest technology in marine advancements. To see the many unique designs we have patented visit our website www.sleipnergrouper.com/patents

CE Declaration of conformity (DoC)

We, the manufacturer:	Sleipner Motor AS Arne Svendsens gate 6-8, NO 1612 Fredrikstad, Norway	
With ISO 9001 certificate:	1484-2007-AQ-NOR-NA, issued by DNV-GL	
Declare that the product: Product Description: S-Link Display Interface Model Number: SDI-1		
Subject to installation, maintenance and use conforming to their intended purpose, is in conformity with the provisions of the following EU Directives: <ul style="list-style-type: none"> • Radio equipment - Directive 2014/53/EU • Restriction of the Use of certain Hazardous Substances in Electrical and Electronic Equipment (RoHS) - Directive 2011/65/EU 		
The product is designed to meet the standards and criteria outlined in:	Radio	EN 300 328 V2.2.2 EN 301 893 V2.1.1 EN 50385:2017
	EMC	EN 60945:2002 IEC 60533:2015 EN 301 489-1 V2.2.0 EN 301 489-17 V3.2.0
	Safety	EN 62368-1:2020 EN 62311:2008
	RoHS	EN 63000:2018

This declaration of conformity is issued under the exclusive responsibility of the manufacturer.

Fredrikstad, 24th of October 2022

Ronny Skauen, President and CEO



UK Declaration of conformity (DoC)

We, the manufacturer:	Sleipner Motor AS Arne Svendsens gate 6-8, NO 1612 Fredrikstad, Norway	
With ISO 9001 certificate:	1484-2007-AQ-NOR-NA, issued by DNV-GL	
Declare that the product:	<p>Product Description: S-Link Display Interface</p> <p>Model Number: SDI-1</p>	
Subject to installation, maintenance and use conforming to their intended purpose; is in conformity with the provisions of the following UK Regulations:	<ul style="list-style-type: none"> • Radio Equipment Regulations 2017 • The Restriction of the Use of Certain Hazardous Substances in Electrical and Electronic Equipment Regulations - 2012 	
The product is designed to meet the standards and criteria outlined in:	Radio	EN 300 328 V2.2.2 EN 301 893 V2.1.1 EN 50385:2017
	EMC	EN 60945:2002 IEC 60533:2015 EN 301 489-1 V2.2.0 EN 301 489-17 V3.2.0
	Safety	EN 62368-1:2020 EN 62311:2008
	RoHS	EN 63000:2018

This declaration of conformity is issued under the exclusive responsibility of the manufacturer.

Fredrikstad, 24th of October 2022

Ronny Skauen, President and CEO

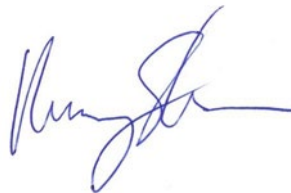

© **Sleipner Group**, All rights reserved
The information given in the document
was right at the time it was published.
However, Sleipner Group cannot
accept liability for any inaccuracies or
omissions it may contain. Continuous
product improvement may change the
product specifications without notice.
Therefore, Sleipner Group cannot accept
liability for any possible differences
between product and document.

Learn more about our products at
www.sleipnergroun.com



SLEIPNER MOTOR AS

P.O. Box 519

N-1612 Fredrikstad

Norway

www.sleipnergroun.com

Made in Norway